

ASSEMBLY INSTRUCTIONS

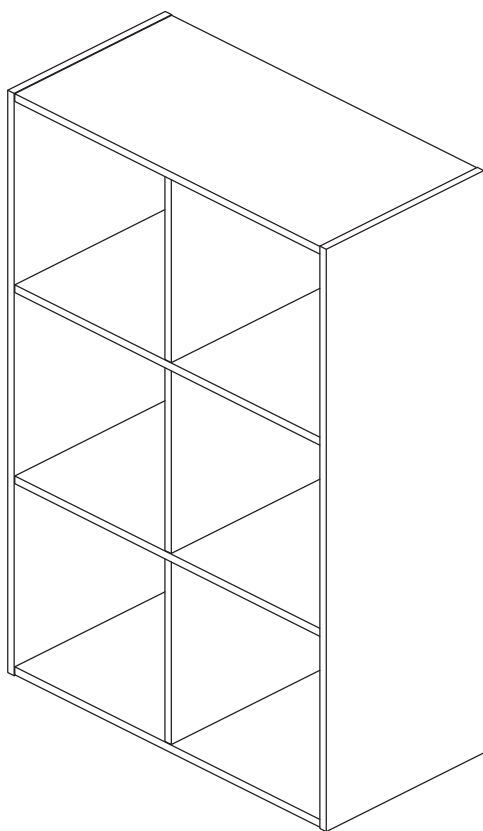

TOOLS REQUIRED



Philips Screwdriver

(Not Included)



Power Tool

(Not Included)

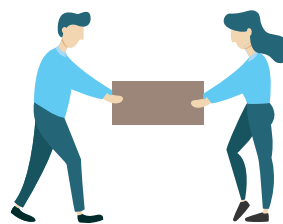

**2 - People
Recommended**

BOOKCASE

PRE ASSEMBLY INTRODUCTION

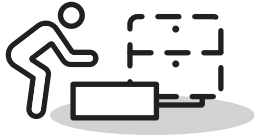

Assemble near the area of the intended location.



Make sure you have enough space to move around.



Use cardboard or blankets to prevent scratches.



Ensure the furniture rests on a flat and level surface.

ASSEMBLY AND CARE ADVICE



FAILURE TO FOLLOW THE GUIDELINES BELOW MAY RESULT IN INJURY AND/OR PROPERTY DAMAGE.



Position each part correctly and insert screws or bolts into their respective holes.

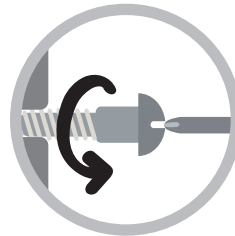

Turn clockwise to tighten and only tighten when step is completed or when instructed to do so.



Use the appropriate hand tools or power tools for assembly.

Select steps, such as tightening screws and/or bolts, may require hand tools to avoid causing damage during assembly.

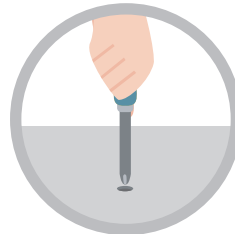

After two weeks, check and tighten any loose hardware and repeat again every six months thereafter.

ASSEMBLY INSTRUCTIONS

PARTS

A 2PCS

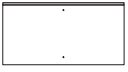

Top & Bottom Panels
(single-edge groove)

B 2PCS

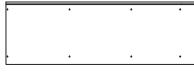

Side Panels

C 2PCS

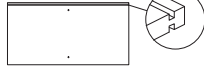

Shelf
(double-sided grooves)

D 3PCS



Back Panels

E 3PCS



Divider Panels

HARDWARE

1 16PCS



2 8PCS



3 4PCS

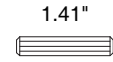

4 20PCS



5 1PC



6 8SETS



7 1SET

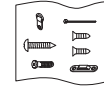

1

- Insert short wooden dowels (#2) into one side of Divider Panels (#E). Repeat once.
- Connect Shelf (#C) to Divider Panels (#E) with longer wooden dowels (#3).
- Align and connect Top and Bottom Panels (#A) to Divider Panels (#E).
- Align one Side Panel (#B) and secure with screws (#1). Slide in Back Panels (#D).
- Join remaining Side Panel (#B) and secure with screws (#1).

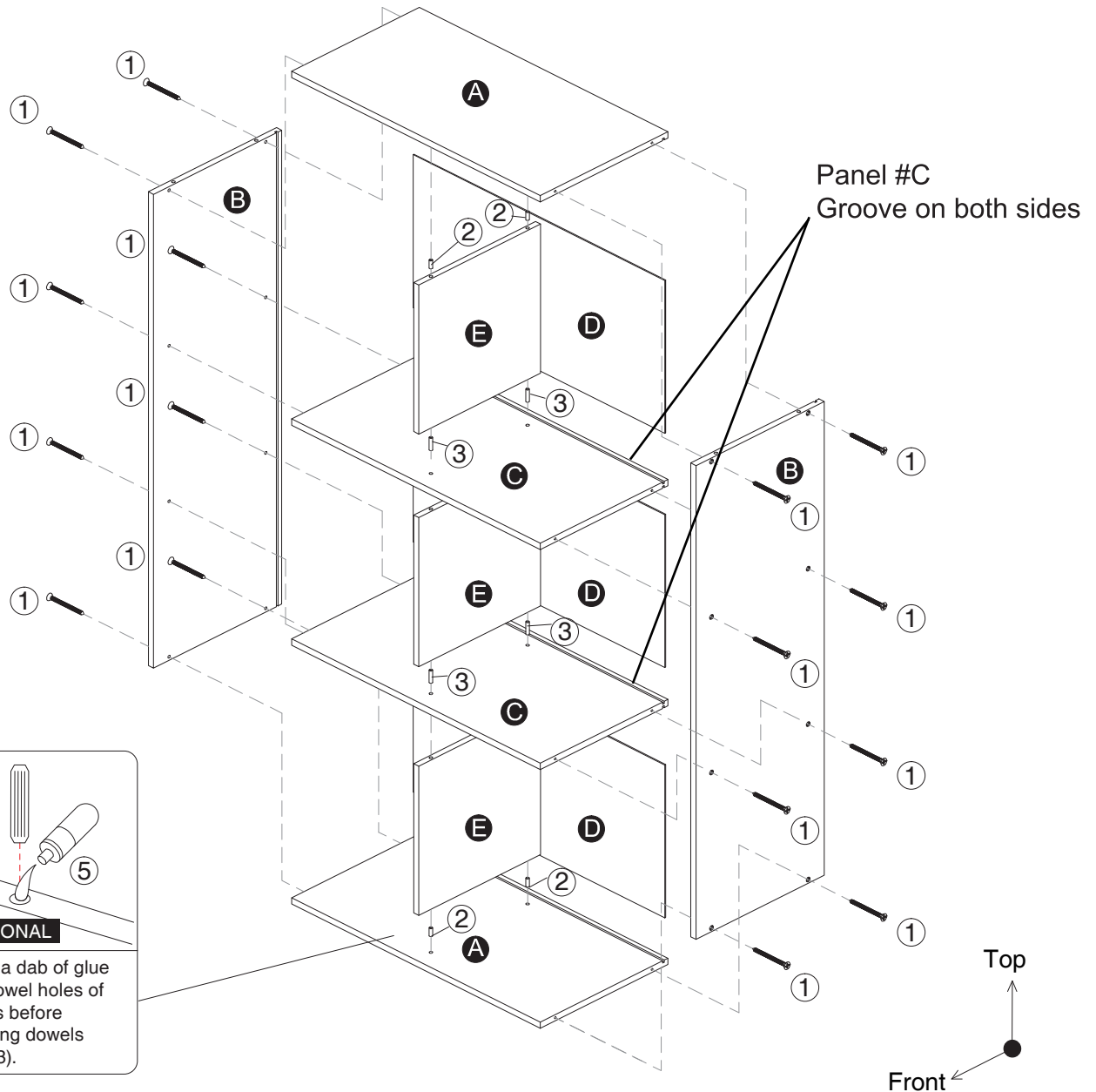

ASSEMBLY INSTRUCTIONS

2

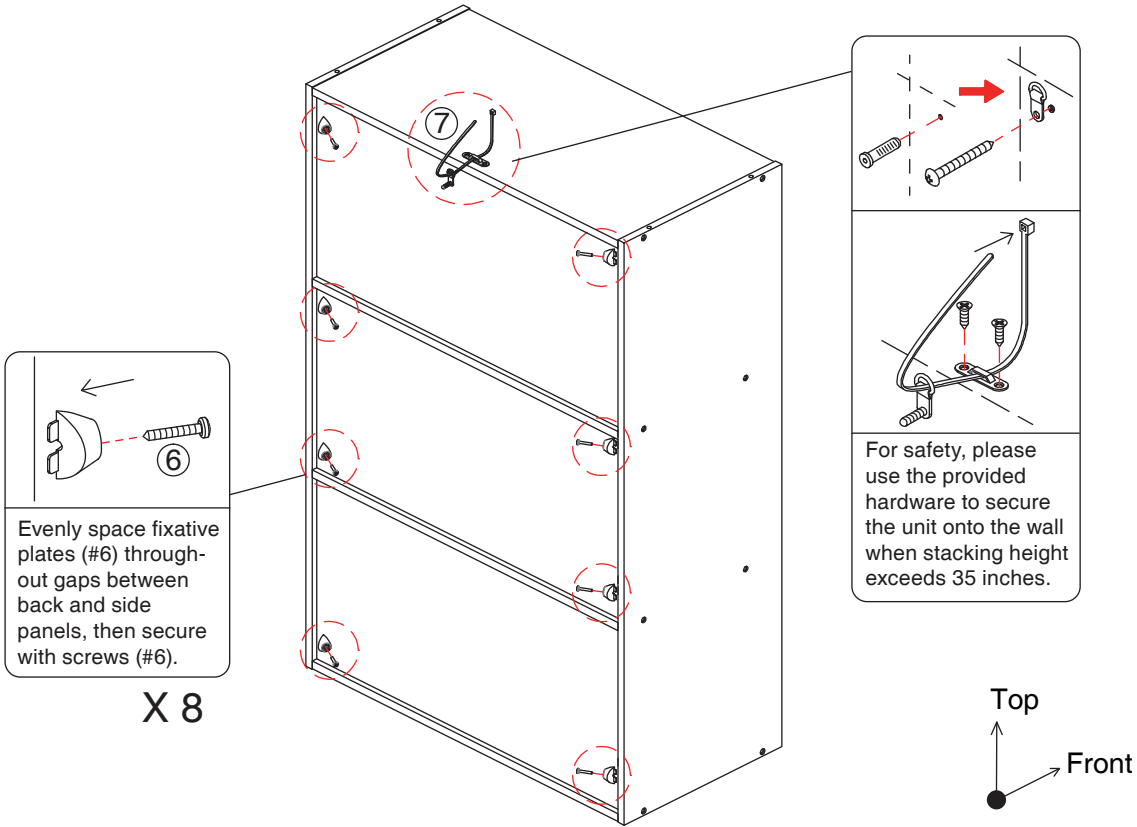

3

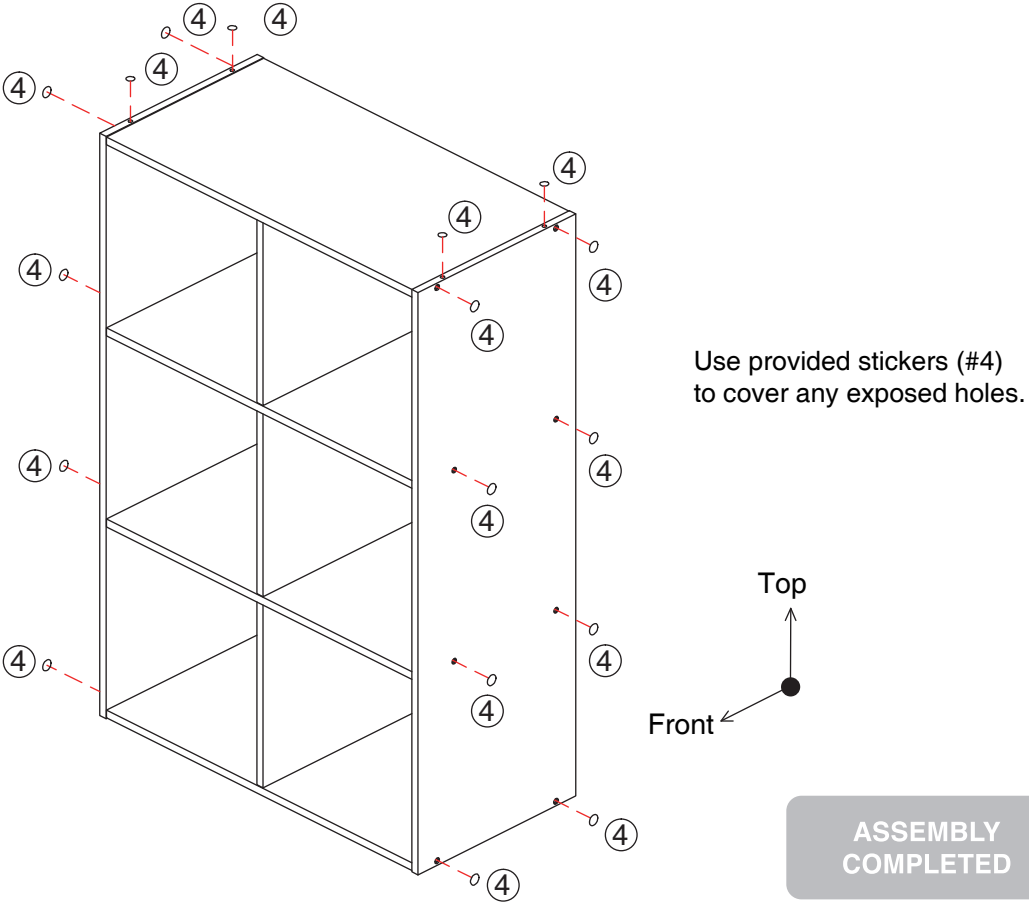



Safety Measures for Stacking

A maximum of **2** units can be stacked.

The total stacked height cannot exceed **70.6"**

The use of wooden dowels and anti-tip hardware is required when stacking height exceeds **35.0"**

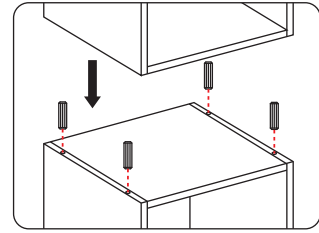

Refrain from drilling holes on your own.

Please make sure to use the pre-drilled holes and dowels (#2) for stacking.

Mix, Match & Stack

This item can be stacked with other compatible pieces in the collection. Configurations shown may include multiple units, which are sold separately unless otherwise stated.

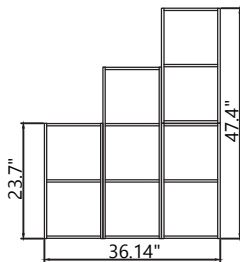

2S
2S · 3S · 2S

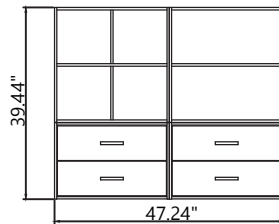

4S · 2L
2D · 2D

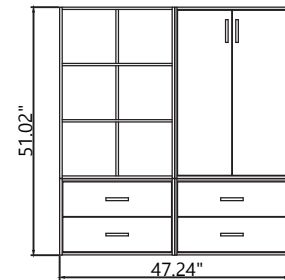

6S · DC
2D · 2D

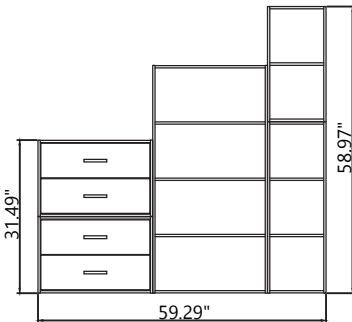

2D 2S
2D · 4L · 3S

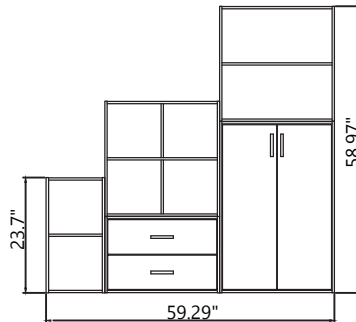

4S · 2L
2S · 2D · DC

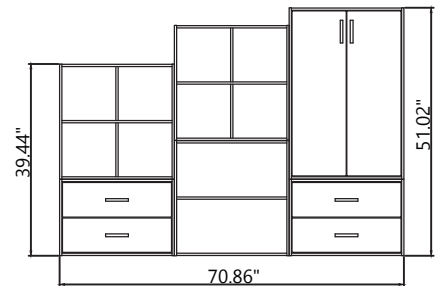

4S · 4S · DC
2D · 2L · 2D

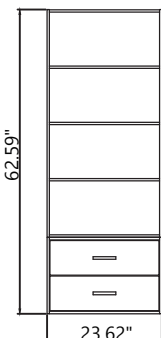

4L
2D

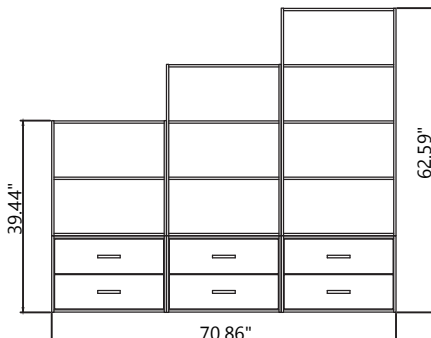

2L · 3L · 4L
2D · 2D · 2D

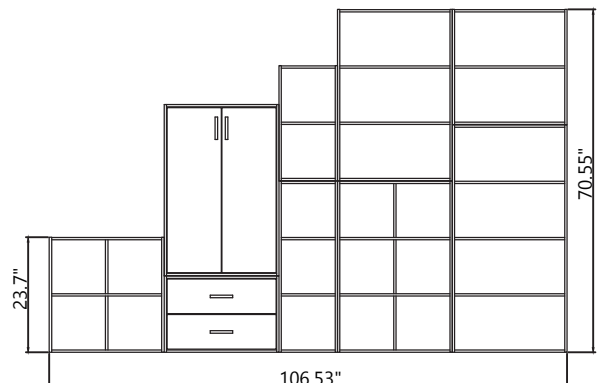

DC · 2S · 3L · 2L
4S · 2D · 3S · 6S · 4L