

ASSEMBLY INSTRUCTIONS

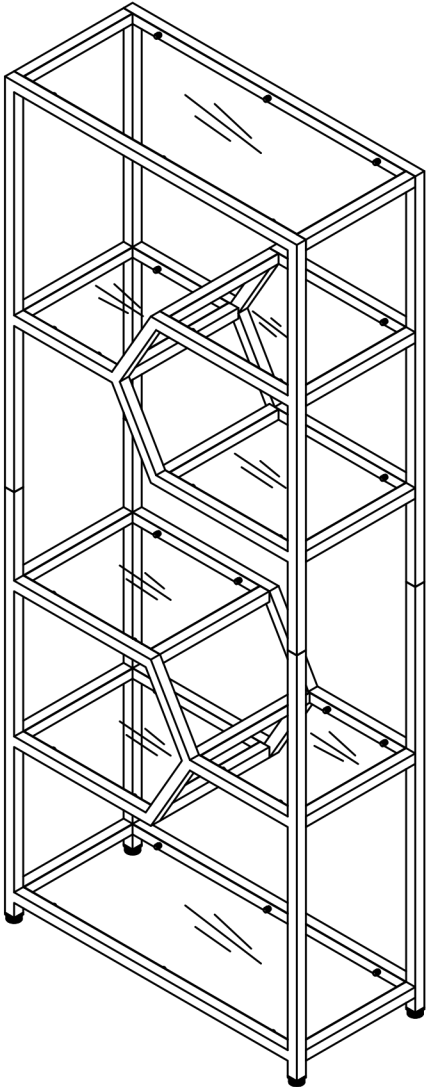

TOOLS REQUIRED



Allen Wrench
(Included)



2 - People
Recommended

ASSEMBLY RATING



EASY —————> DIFFICULT

The Assembly Rating is a 5-point system showing the level of effort needed to assemble a specific product.



CHECK BEFORE STARTING

Are you missing anything?

Double-check all parts, hardware and accessories listed on Page 6 are accounted for.

Check out our Quick Tips!

We recommend reviewing the pre-assembly handouts. Even experts need a refresher now and then!

Should we send any replacements?

Are there any irregularities or flaws in the parts? We can send replacements!

Prep Time!

Please review the assembly instructions and all diagrams prior to assembling. Arrange parts as recommended on Page 7 and group identical hardware together to make assembling easier.

PRE ASSEMBLY INTRODUCTION

We understand building ready-to-assemble furniture can be a challenging experience for some. To help avoid confusion, we have provided some helpful tips that may speed up the process.

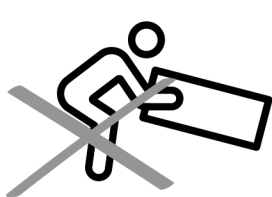

Teamwork

ALWAYS have at least two people to help with transporting and assembling the product to avoid potential injury and/or damage.

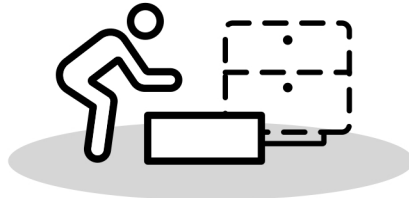
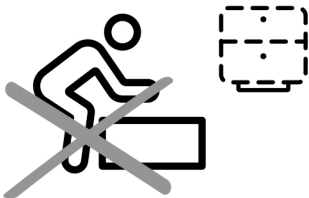

Suitable Location

Assembling near the area of the intended location is highly recommended.



Sufficient Space

Make sure you have enough space to move around during the assembly.

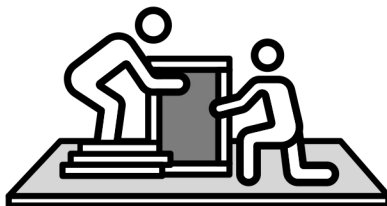

Avoid Scratches

Use cardboard, blankets or a carpeted area while assembling furniture to prevent scratches.

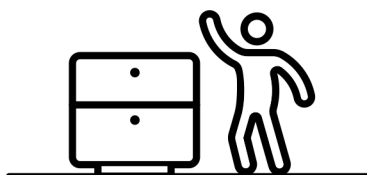
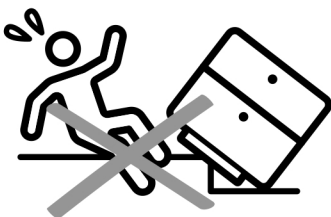

Flat Surface

Make sure the furniture rests on a flat and level surface with each leg evenly touching the floor.

ASSEMBLY AND CARE ADVICE



FAILURE TO FOLLOW THE GUIDELINES BELOW MAY RESULT IN INJURY AND/OR PROPERTY DAMAGE.



Position each part correctly and insert screws or bolts into their respective holes.



Use the appropriate hand tools or power tools for assembly. Select steps, such as tightening screws and/or bolts, may require hand tools to avoid causing damage during assembly.

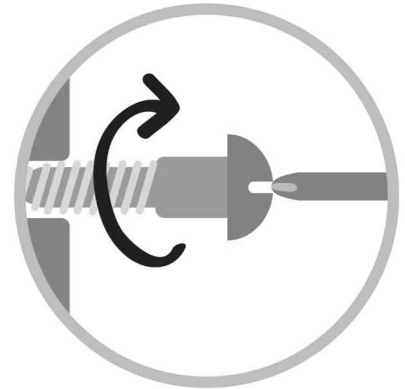

Turn clockwise to tighten and only tighten when step is completed or when instructed to do so.



Save the instructions and store any supplied tools for later maintenance.



After two weeks, check and tighten any loose hardware and repeat again every six months thereafter.

IT IS THE USER'S RESPONSIBILITY TO MAINTAIN THE FURNITURE. THE HARDWARE MAY LOOSEN OVER TIME AND MAY CAUSE THE FURNITURE TO BE WOBBLY AND UNABLE TO SUPPORT ITS INTENDED WEIGHT CAPACITY. THIS MAY LEAD TO COLLAPSE AND MAY CAUSE SERIOUS INJURY.

BOOKCASE



- Please keep instructions for future reference.
- Check the quantity and irregularity of parts and hardware before you start.

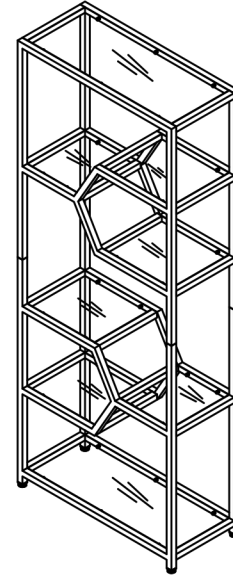

PARTS

#1 1pc

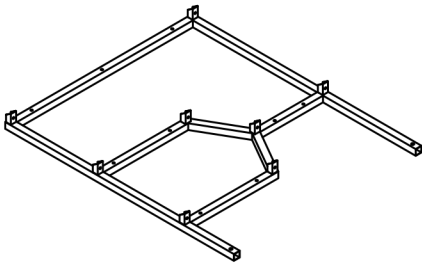

Top-Front Frame

#2 1pc

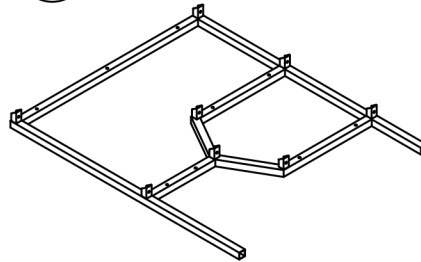

Top-Back Frame

#3 1pc

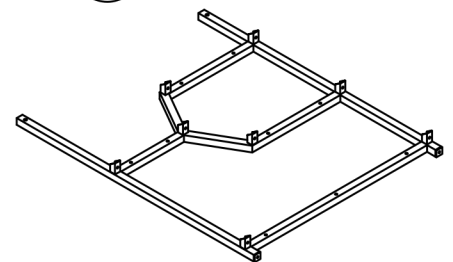

Bottom-Front Frame

#4 1pc

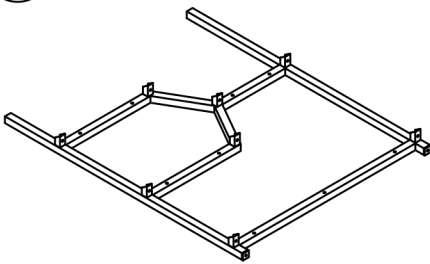

Bottom-Back Frame

#5 16pcs

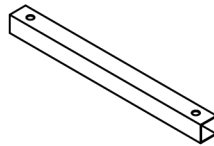

Cross Tube

#6 4pcs

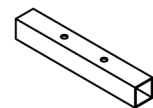

Inner Tube

#7 2pcs

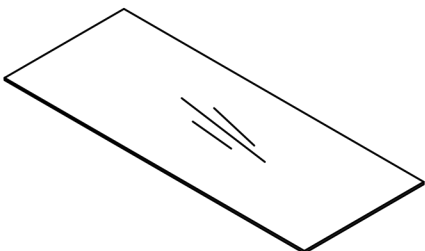

Large Glass

#8 4pcs

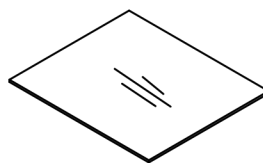

Middle Glass

#9 2pcs

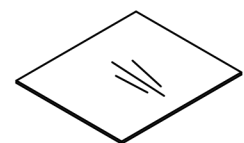

Small Glass

HARDWARE

#A 40pcs

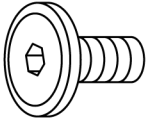

Bolt 1/4" * 12mm

#B 4pcs

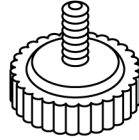

Leveler

#C 36pcs

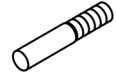

Glass Holder

#D 36pcs



Rubber Tube

#E 2pcs

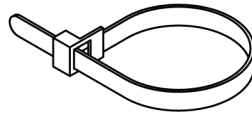

Safety Strap

#F 2pcs

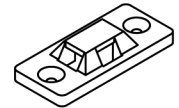

Plastic Bracket

#G 4pcs



Anchor

#H 4pcs



Screw

#I 1pc

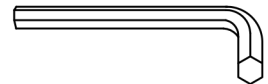

Allen Wrench

ASSEMBLY INSTRUCTIONS

1

- Part #1 x1pc
- Part #2 x1pc
- Part #5 x8pcs
- Hardware #A x16pcs

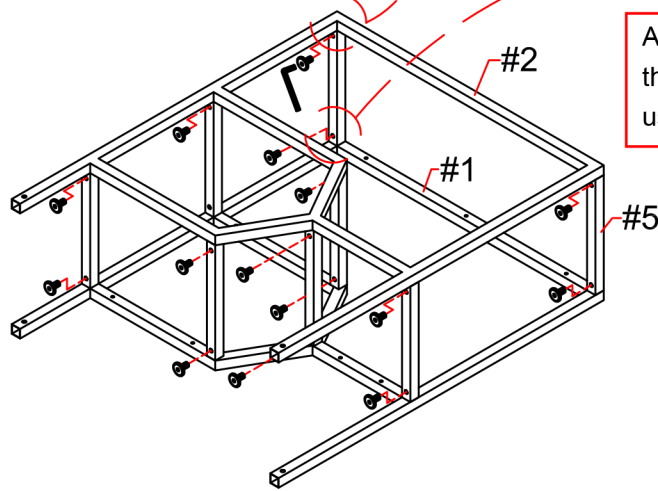
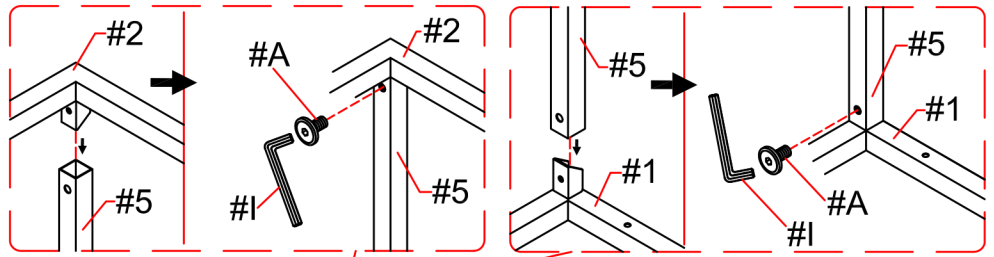

Align and connect cross tubes (#5) to the top frames (#1,2), then secure by using bolts (#A).

2

- Part #3 x1pc
- Part #4 x1pc
- Part #5 x8pcs
- Hardware #A x16pcs

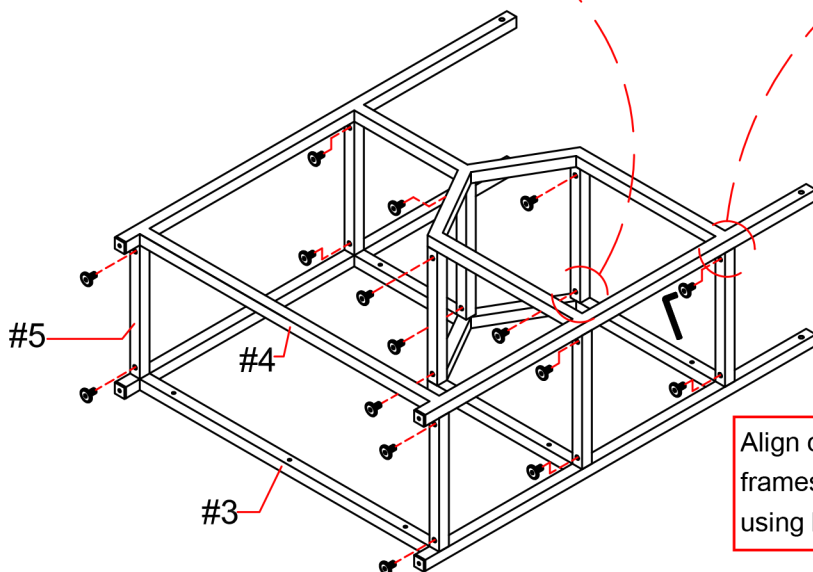
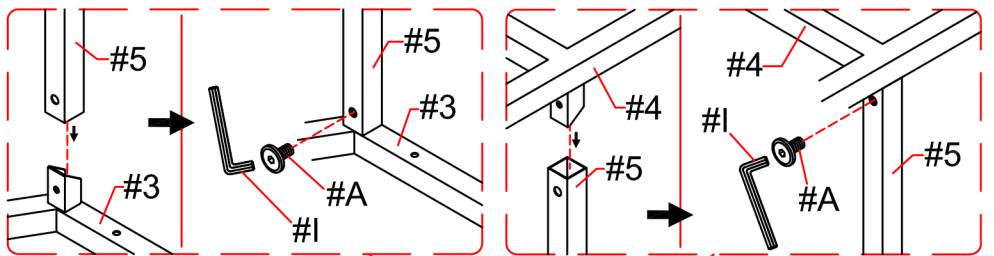

Align cross tubes (#5) to bottom frames (#3,4), then secure by using bolts (#A).

ASSEMBLY INSTRUCTIONS

3

Part #6 x4pcs
Hardware #A x4pcs

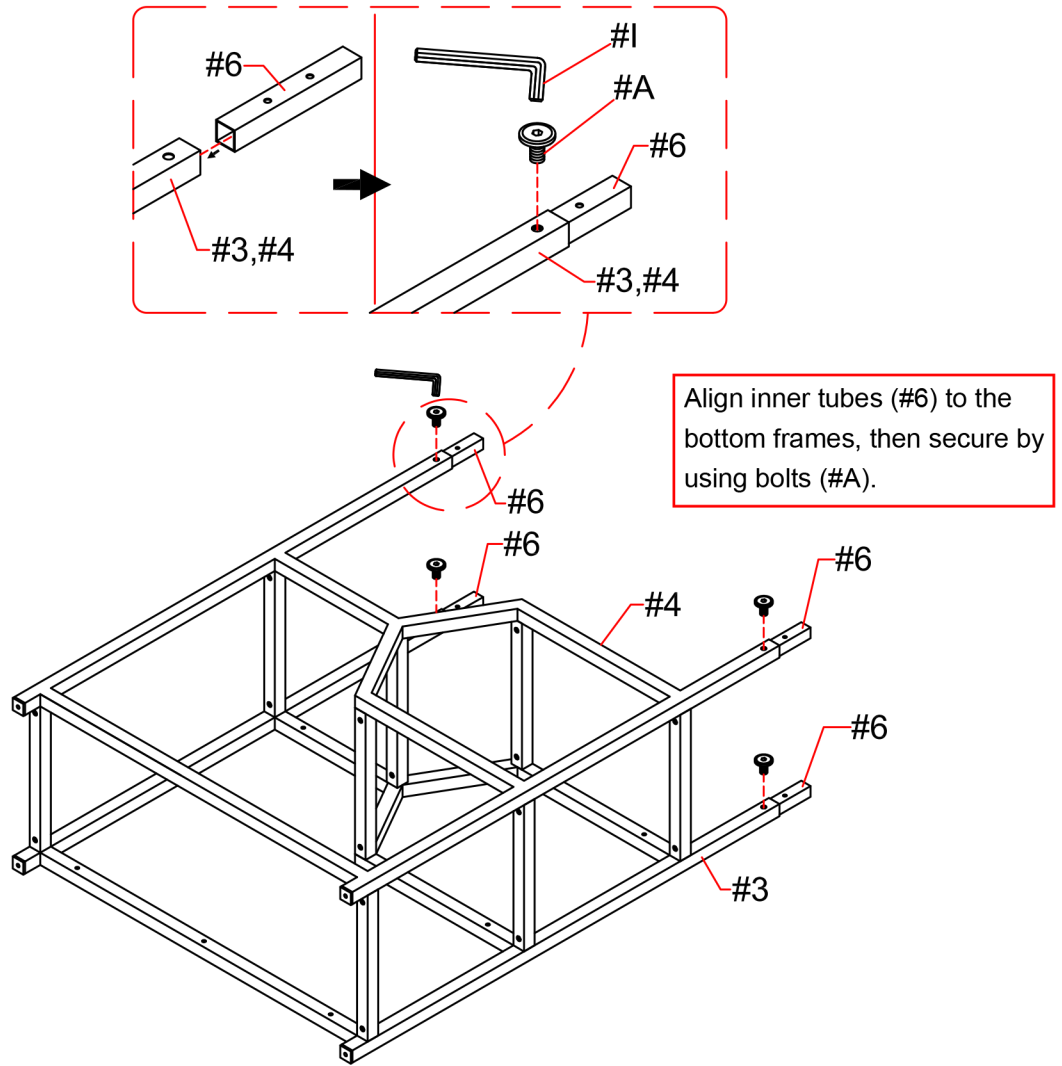

4

Hardware #B x4pcs

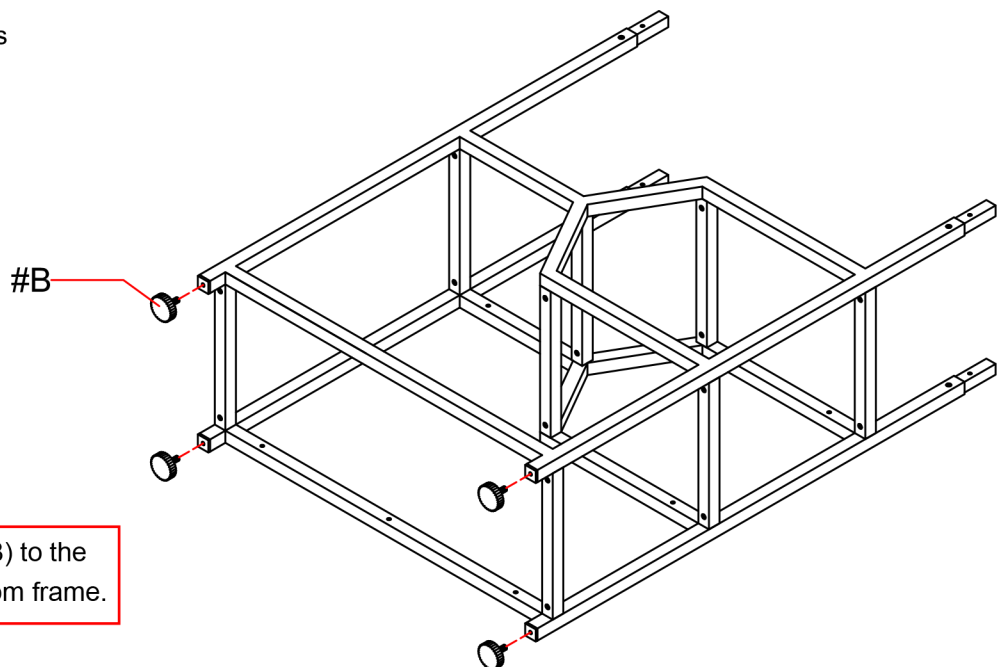

Attach levelers (#B) to the bottom of the bottom frame.

ASSEMBLY INSTRUCTIONS

5

Hardware **#A** x4pcs

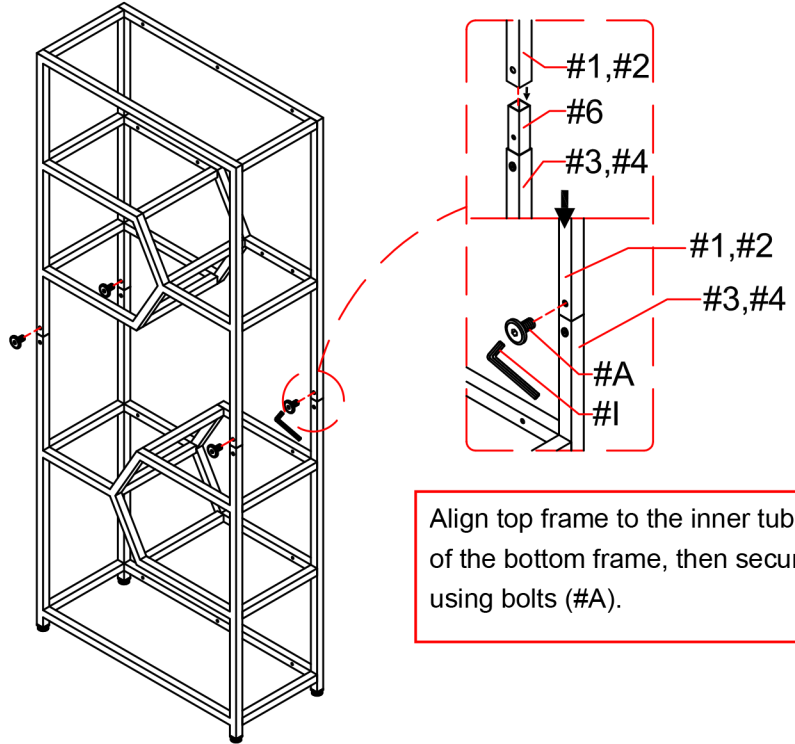

6

Part **#7** x2pcs
Part **#8** x4pcs
Part **#9** x2pcs
Hardware **#C** x36pcs
Hardware **#D** x36pcs

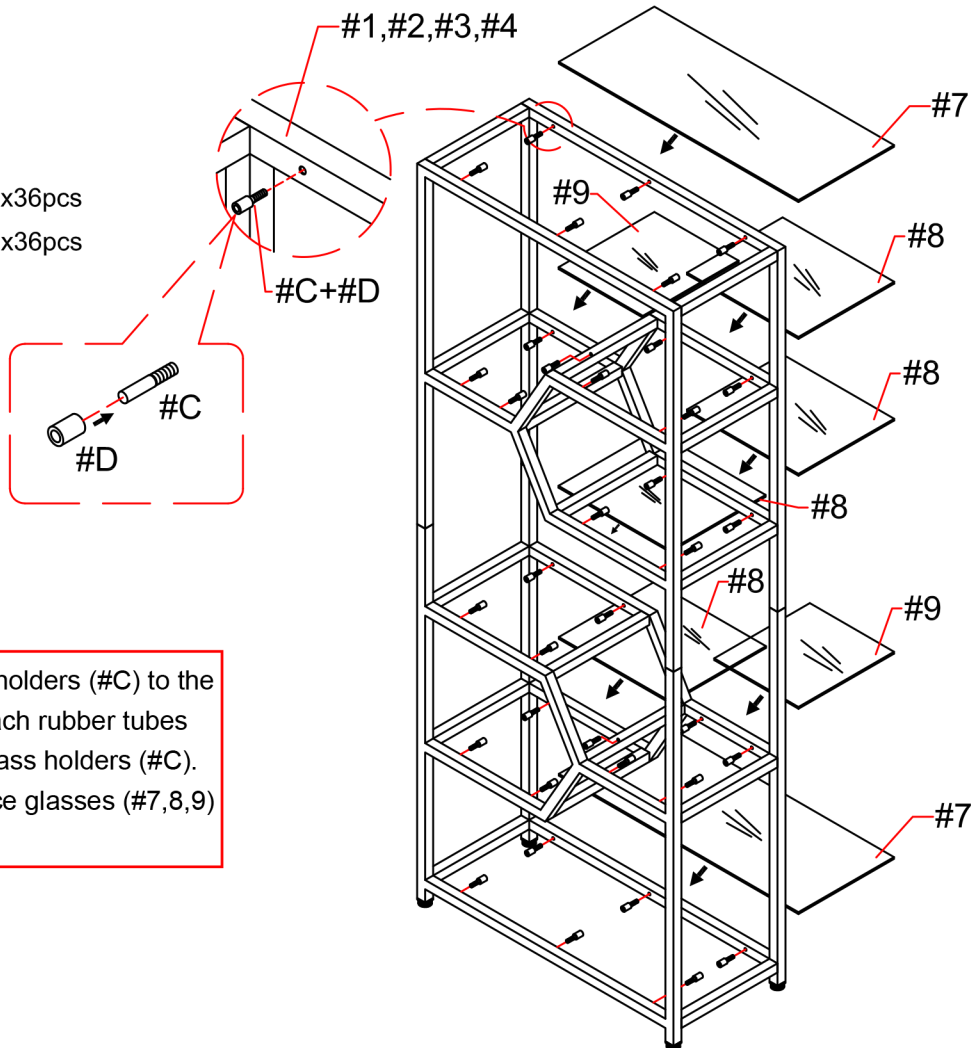

ASSEMBLY INSTRUCTIONS

7

Hardware #E x2pcs

Hardware #F x2pcs

Hardware #G x4pcs

Hardware #H x4pcs

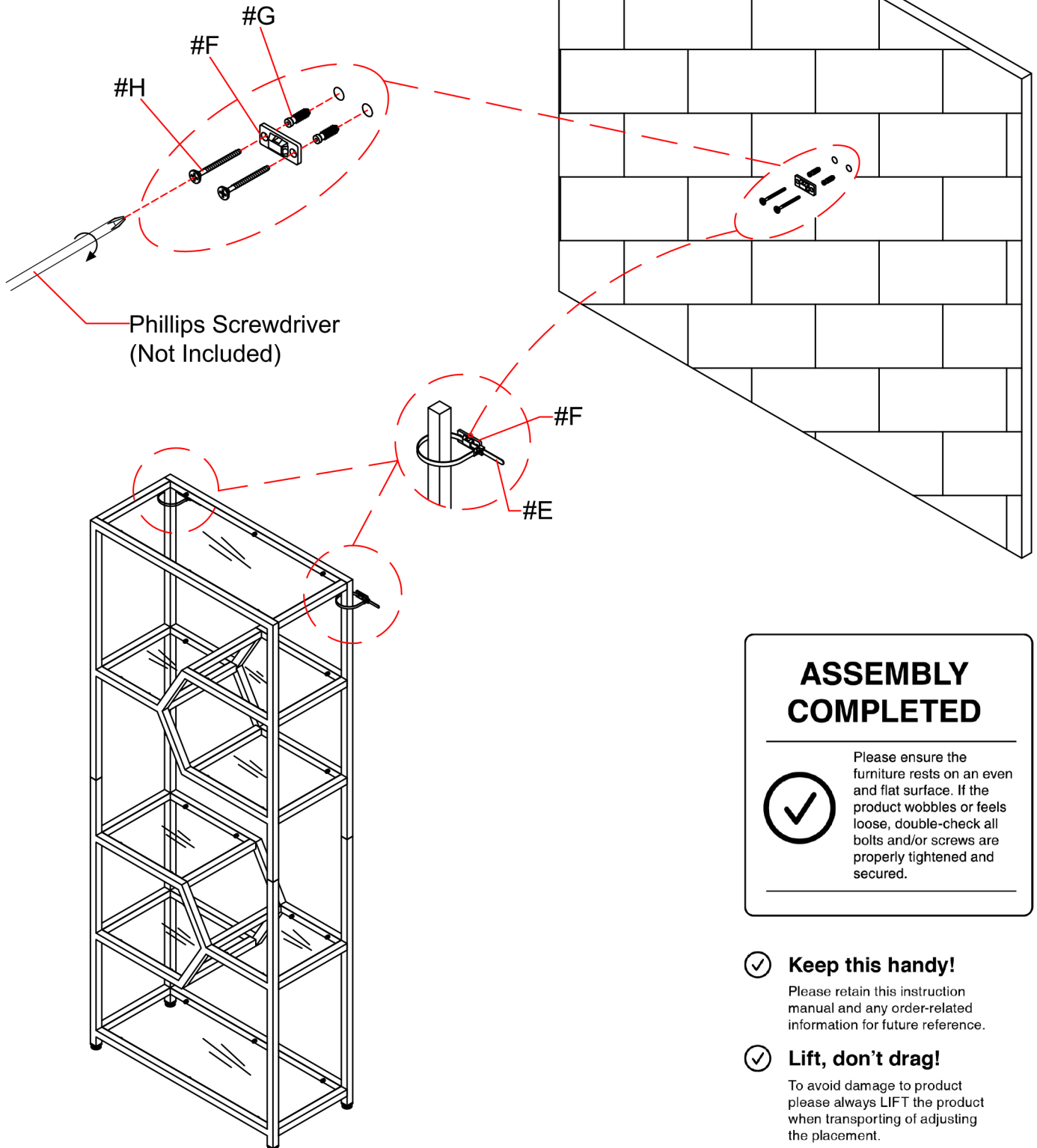

ASSEMBLY COMPLETED



Please ensure the furniture rests on an even and flat surface. If the product wobbles or feels loose, double-check all bolts and/or screws are properly tightened and secured.



Keep this handy!

Please retain this instruction manual and any order-related information for future reference.



Lift, don't drag!

To avoid damage to product please always LIFT the product when transporting or adjusting the placement.

ASSEMBLY INSTRUCTIONS

Wall Mounting and Fixing



EXPANSION WALL ANCHOR

Our provided expansion wall anchors are only suitable for masonry walls, such as drywall, plaster or concrete, and are best for holding lightweight items or for anti-tip prevention. If you are unsure of the correct wall anchor to use with the product, please request professional guidance. Liability for product damage or failure due to using the incorrect anchors will fall on the installer.

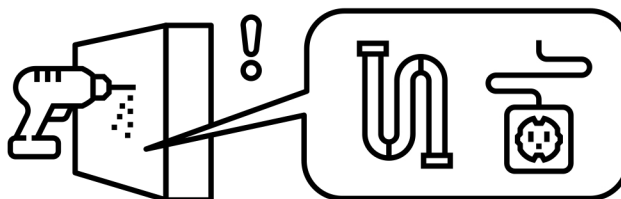

CHECK BEFORE PROCEEDING

Prior to drilling or hammering, please check for wires or pipes. We recommend using a stud finder to locate a stud, which will offer more appropriate resistance and hold more weight.

QUICK TIPS

1. If unsure of the proper size, always choose a larger screw and wall anchor.

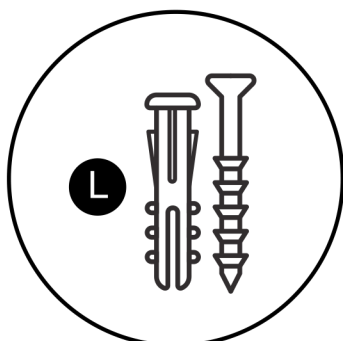

2. Match the drill bit to the wall anchor and hole size.

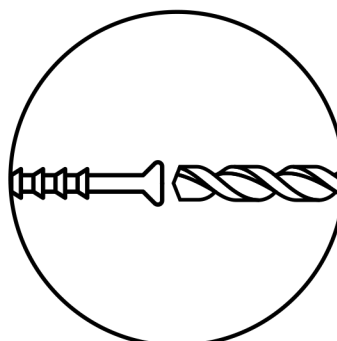

3. Only drill horizontally. Do not force the drill or enlarge the hole for the wall anchor.

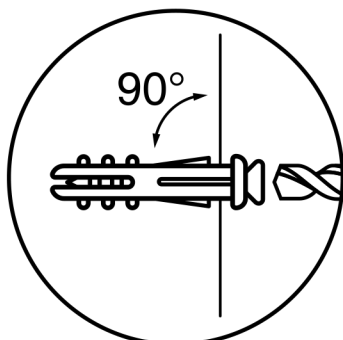

4. Take extra care when drilling into high walls or ceramic tiles. Wall anchors should be a tight fit for the hole. Never use wall anchors in ceilings.

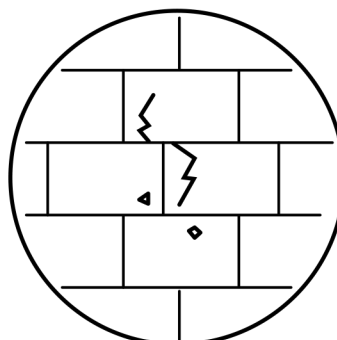

MAINTENANCE



We recommend a yearly check to see if the wall anchor or screw has loosened. If so, please remove the existing wall anchor and screw, and use a new anchor.